

Data Sheet



Article number: 0125095

Description: Retaining ring SP95
Spring steel

Measures

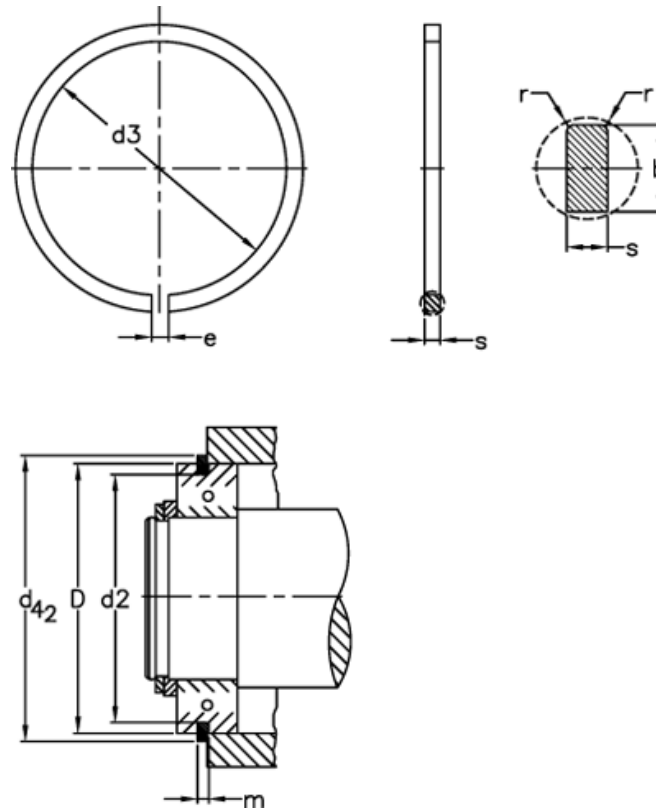

b	= 4.85	FRg kN	= 12.00	tol	= -0.15
D	= 95	FR kN	= 86.8	tol	= -0.1
d2	= 91.82	g	= 3.5	tol	= -0.50
d3	= 90.4	K kN-mm	= 164.0	tol	= 0.3
d42	= 101.6	m	= 2.70	tol	= 0.8
Description	= SP 95	n abl x 1000	= 2.0	Weight kg/1000	= 28.2
e	= 5	r min	= 0.7		
FN kN	= 76.3	s	= 2.46		